

## Комплектация

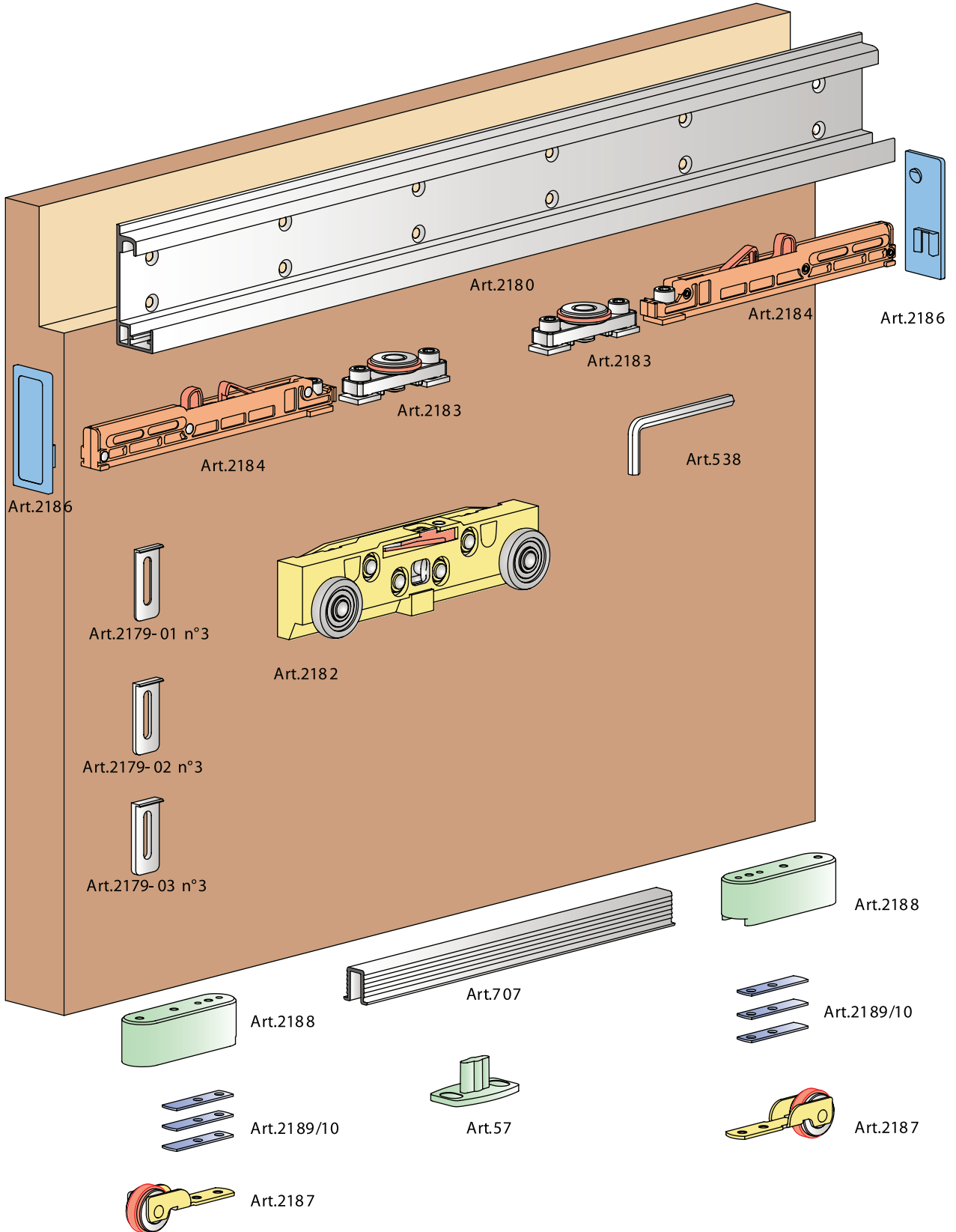

**Варианты комплектов**

I-1100  
Максимум 80кг

Art.2180/A/1095

Art.707/A/950



Art.2183



Art.2179-03 n°3



Ar t.2179-02 n°3

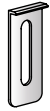

Ar t.2179-01 n°3



FISHER  
SX5 n°2



3,9x19 n°4



Art.538



FISHER  
UX6 n°3



4,5x40 n°3



3,5x20 n°30

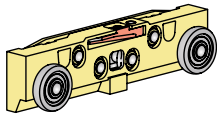

Art.2182

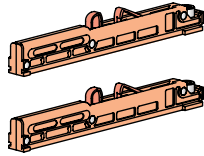

Art.2184



4x30 n°2



Art.57



Art.2188



Art.2187



Art.2189/10

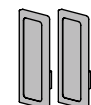

Art.2186/A

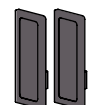

Art.2186/N

I-1800  
Максимум 80кг

Art.2180/A/1795

Art.707/A/1650



Art.2183

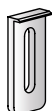

Art.2179-03 n°3



Ar t.2179-02 n°3

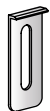

Ar t.2179-01 n°3



FISHER  
SX5 n°2



3,9x19 n°4



Art.538



FISHER  
UX6 n°3



4,5x40 n°3



3,5x20 n°30

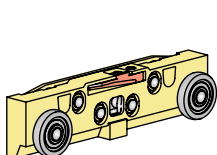

Art.2182

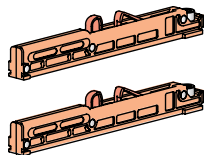

Art.2184



4x30 n°2



Art.57



Art.2188



Art.2187



Art.2189/10

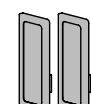

Art.2186/A

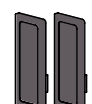

Art.2186/N

# Подготовка дверного полотна и профилей

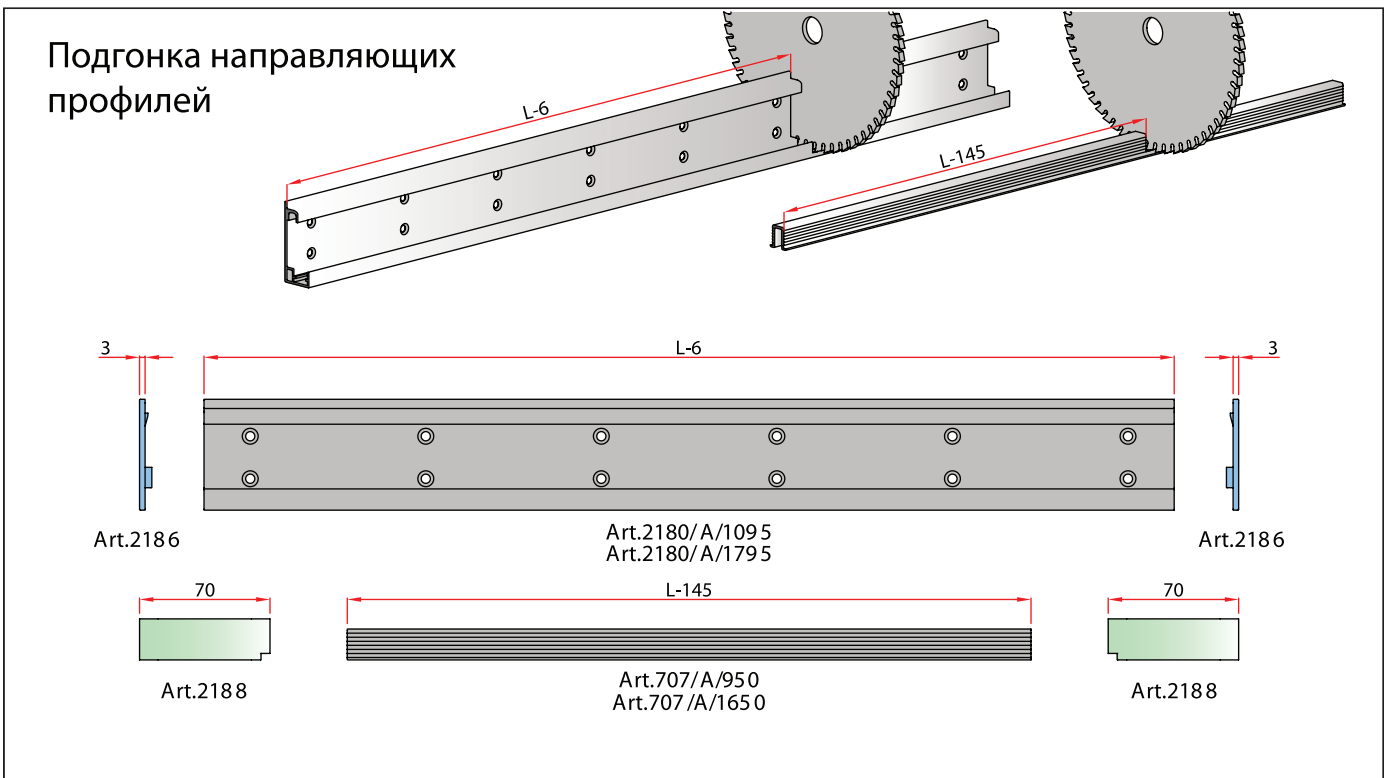
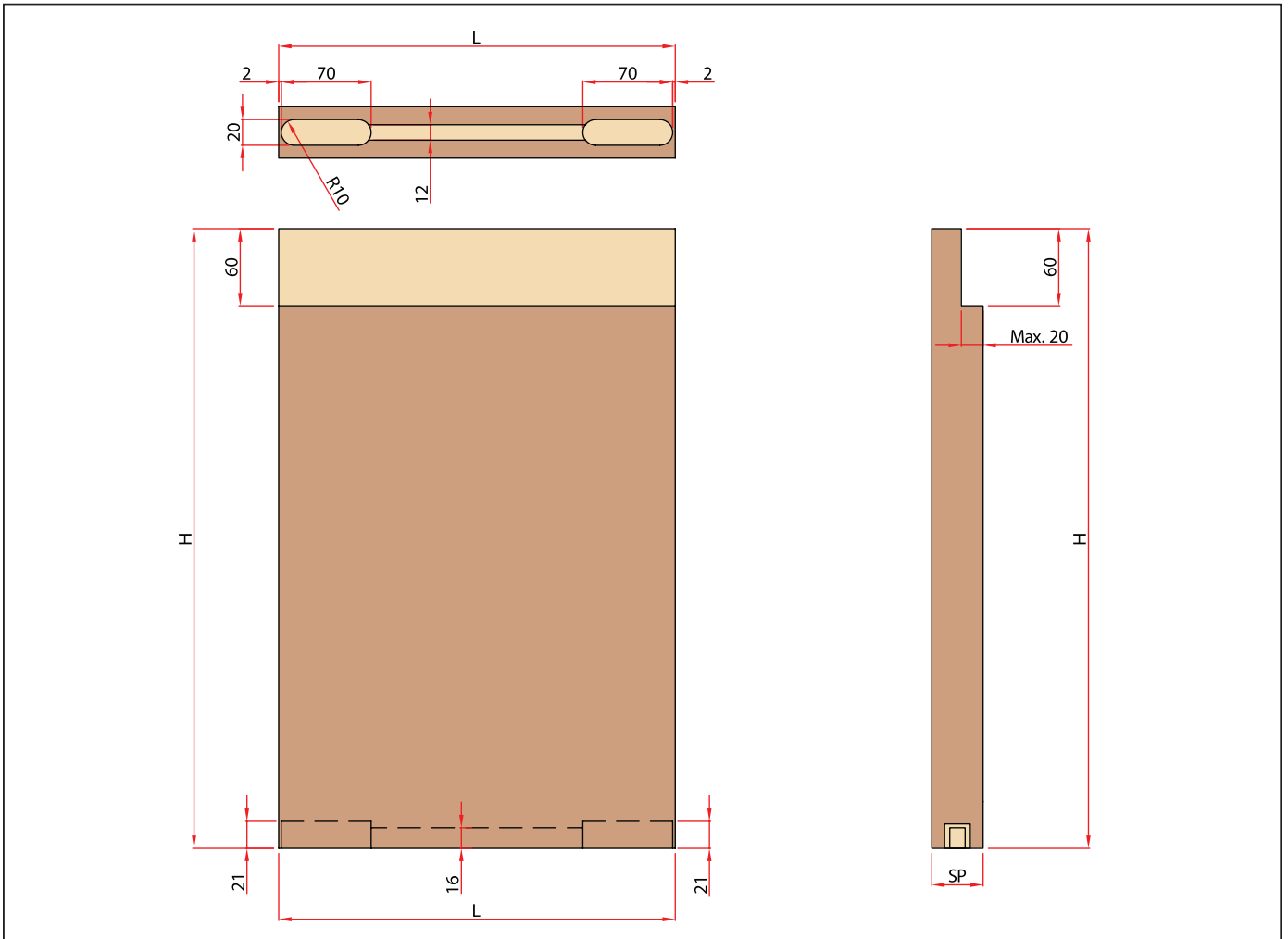

## Варианты установки

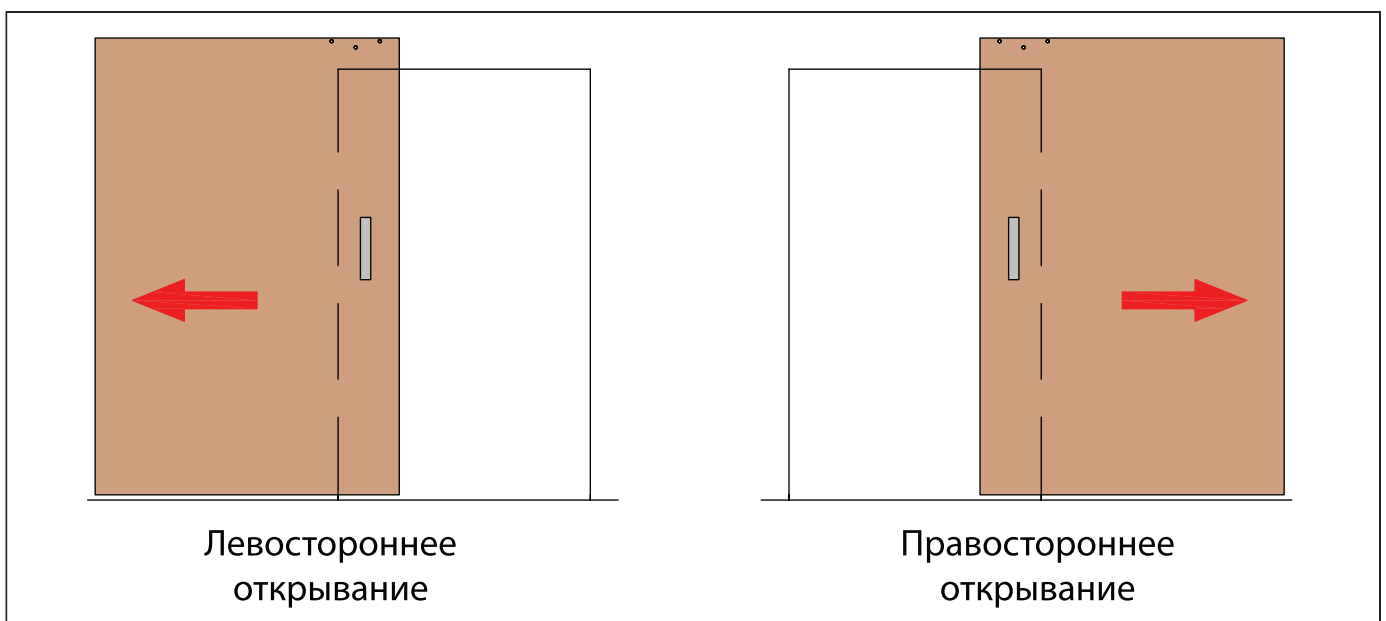
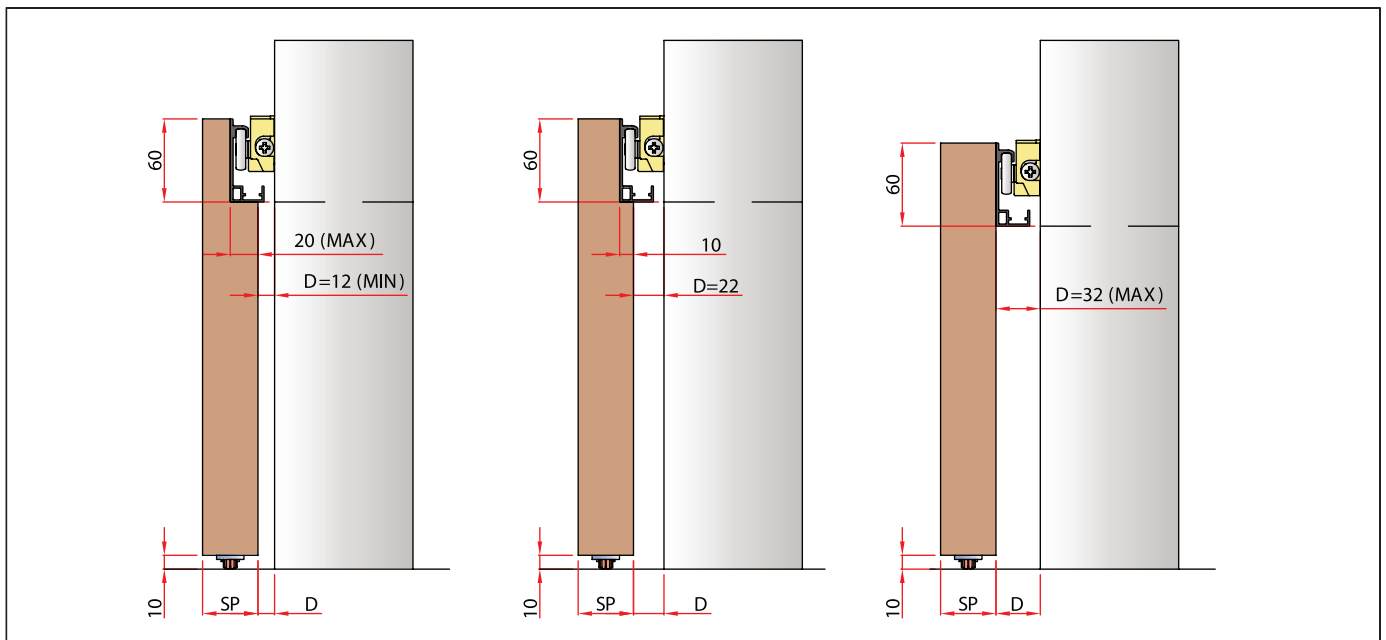
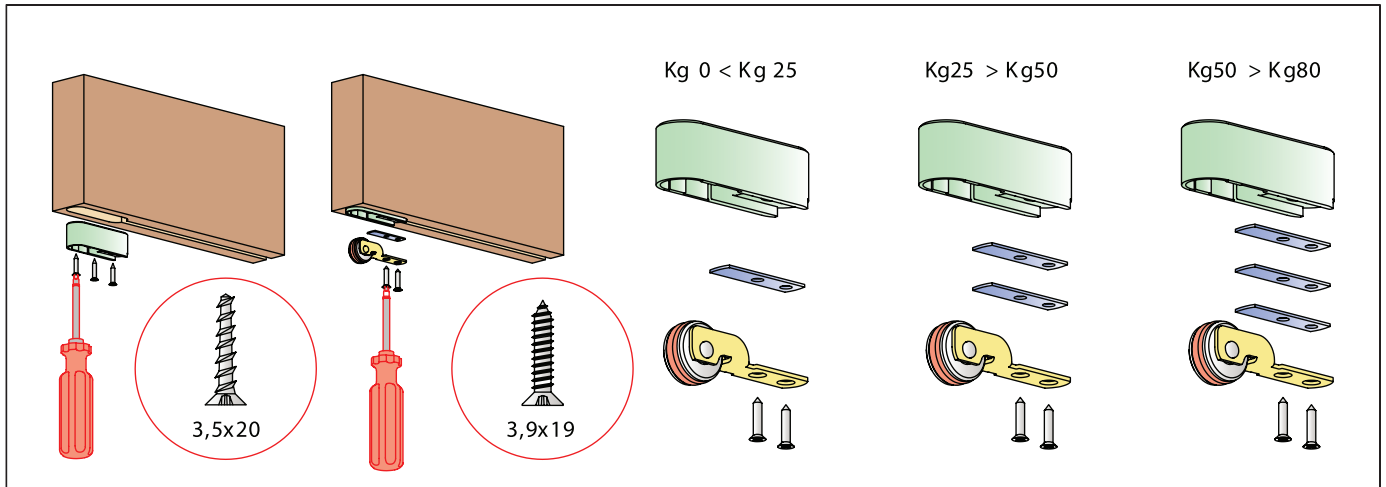

# Вариант установки - стандартный

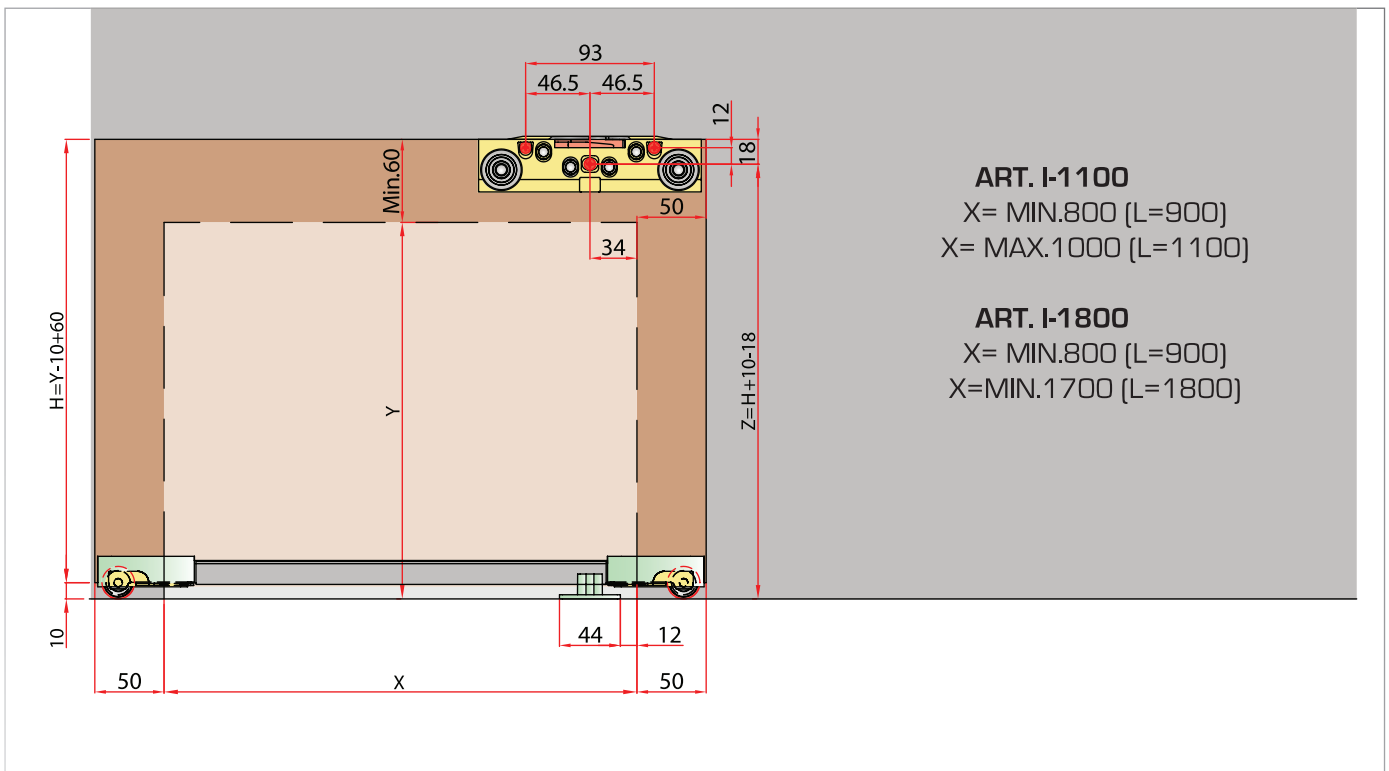
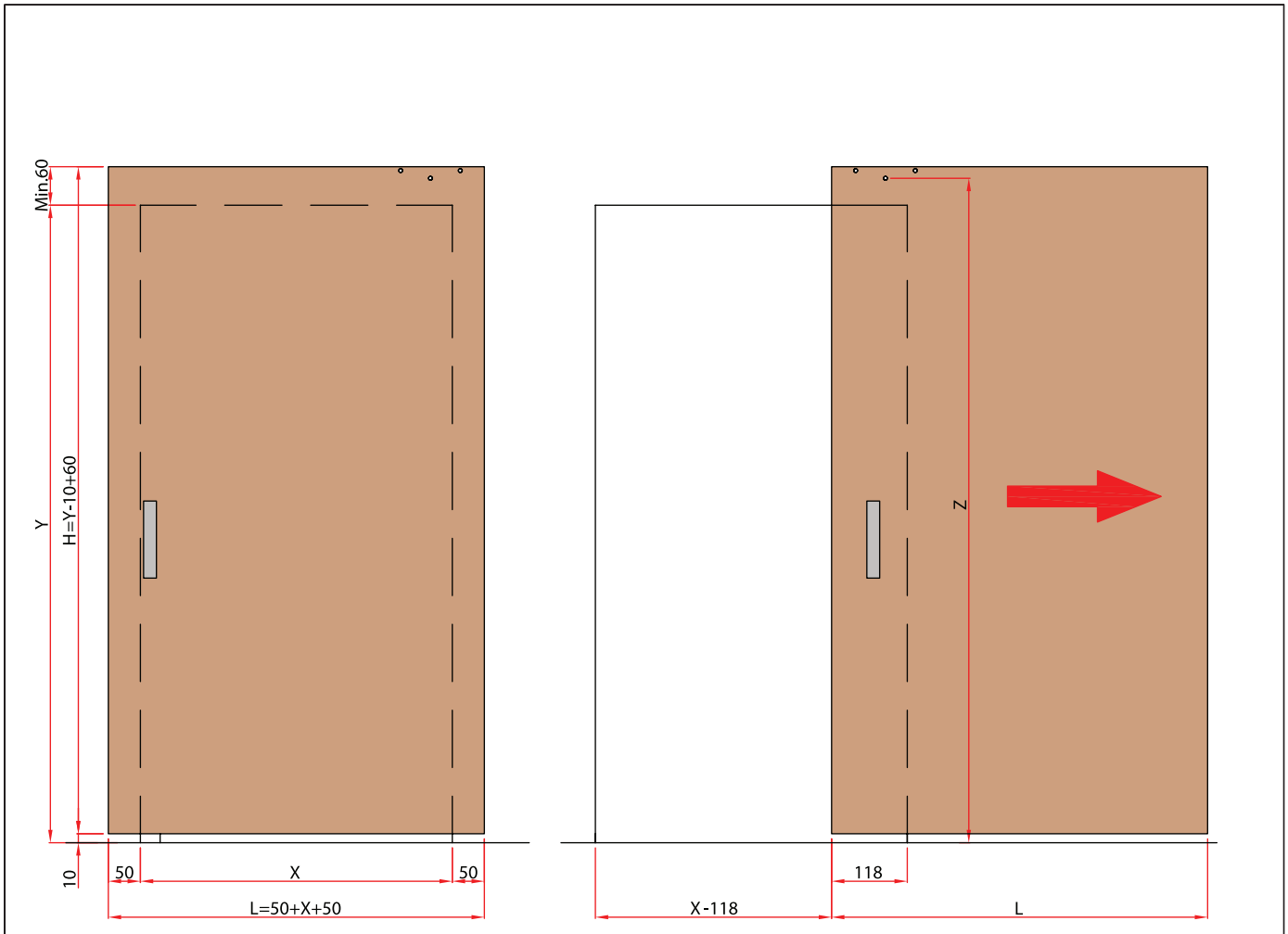

# Вариант установки - промежуточный

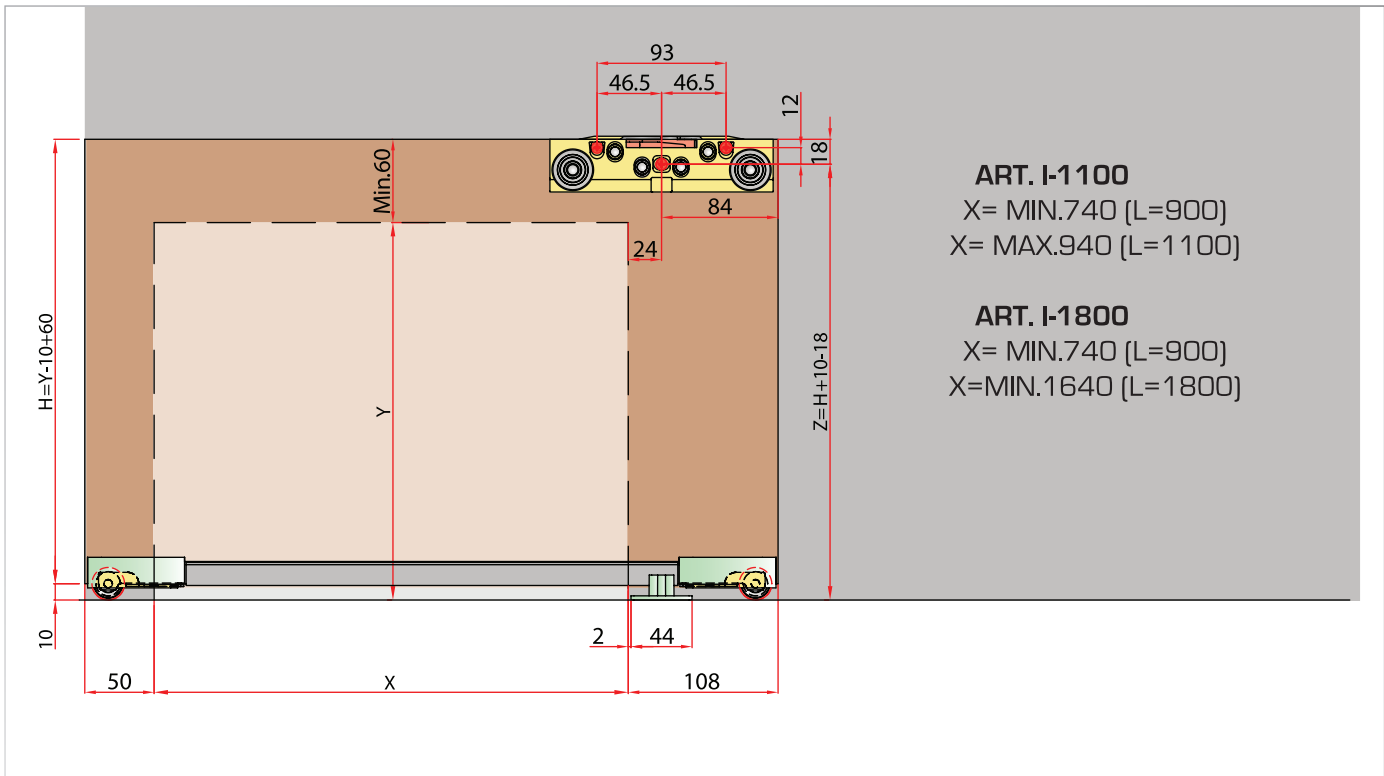
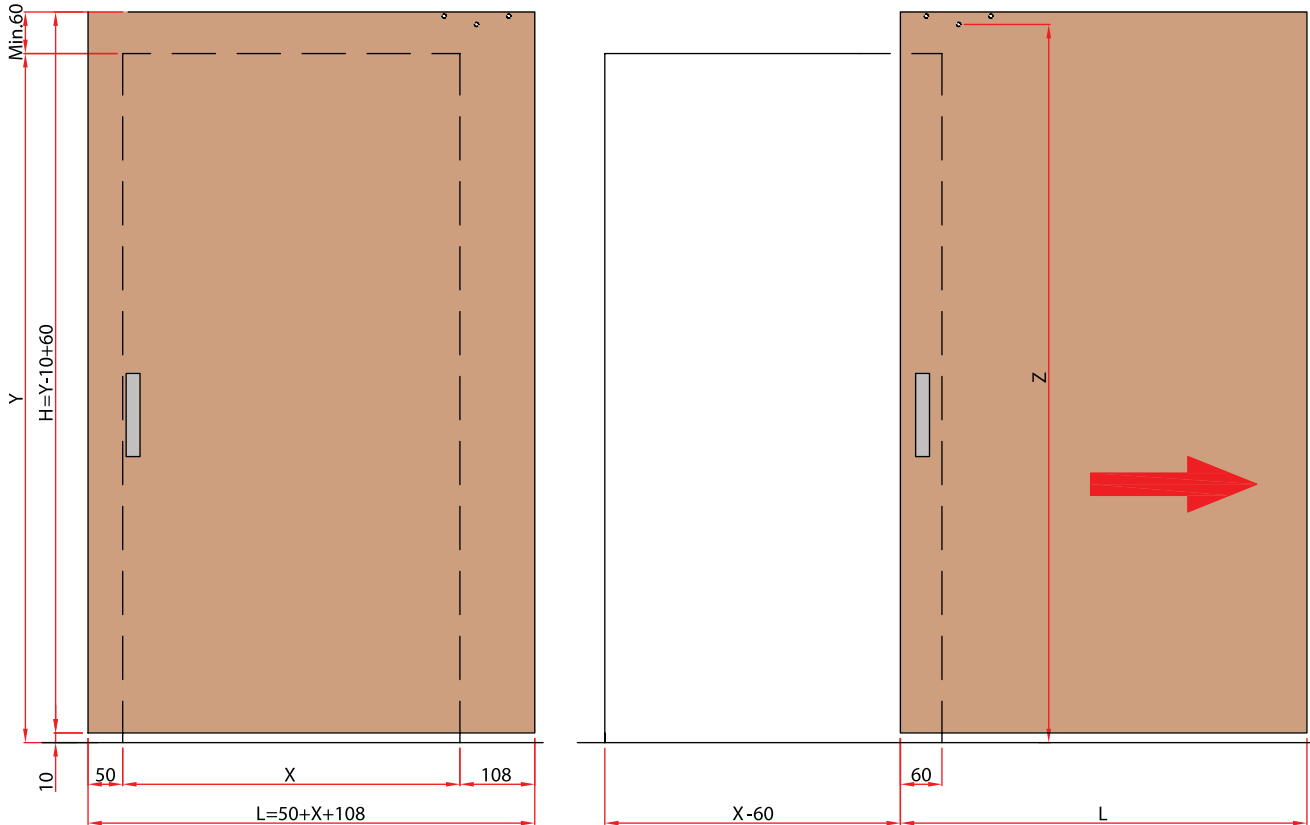

# Вариант установки - полное открытие

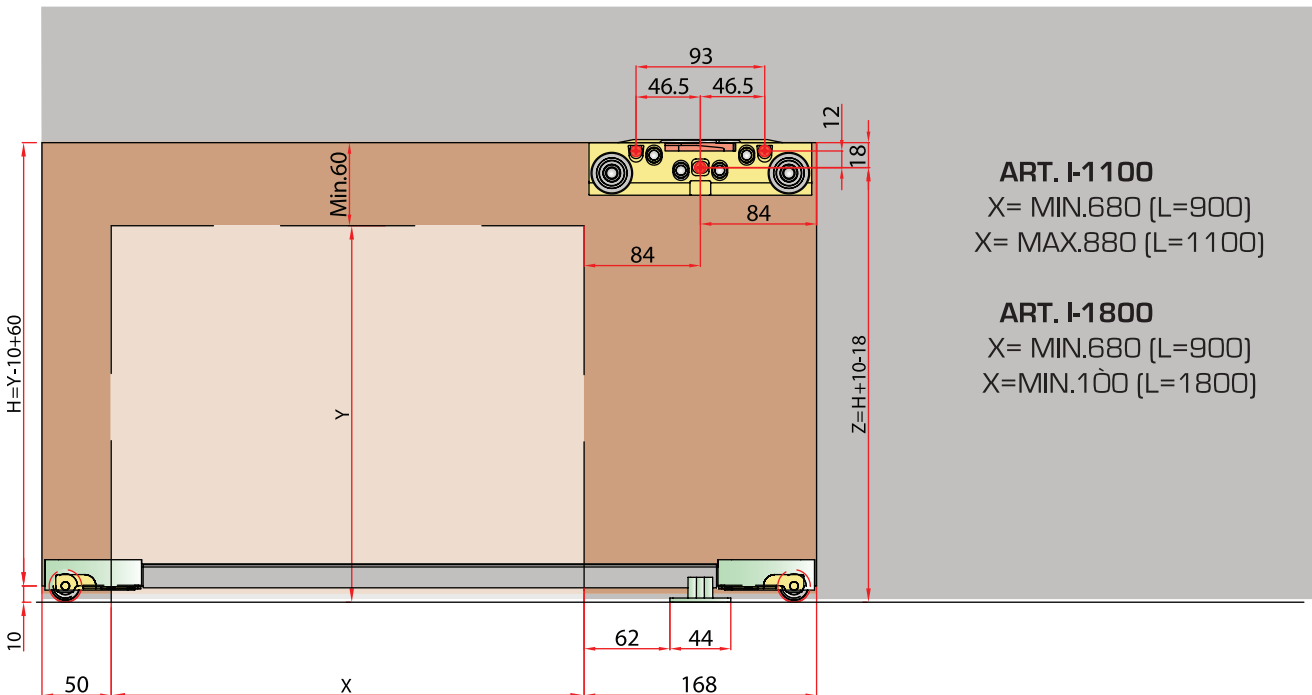
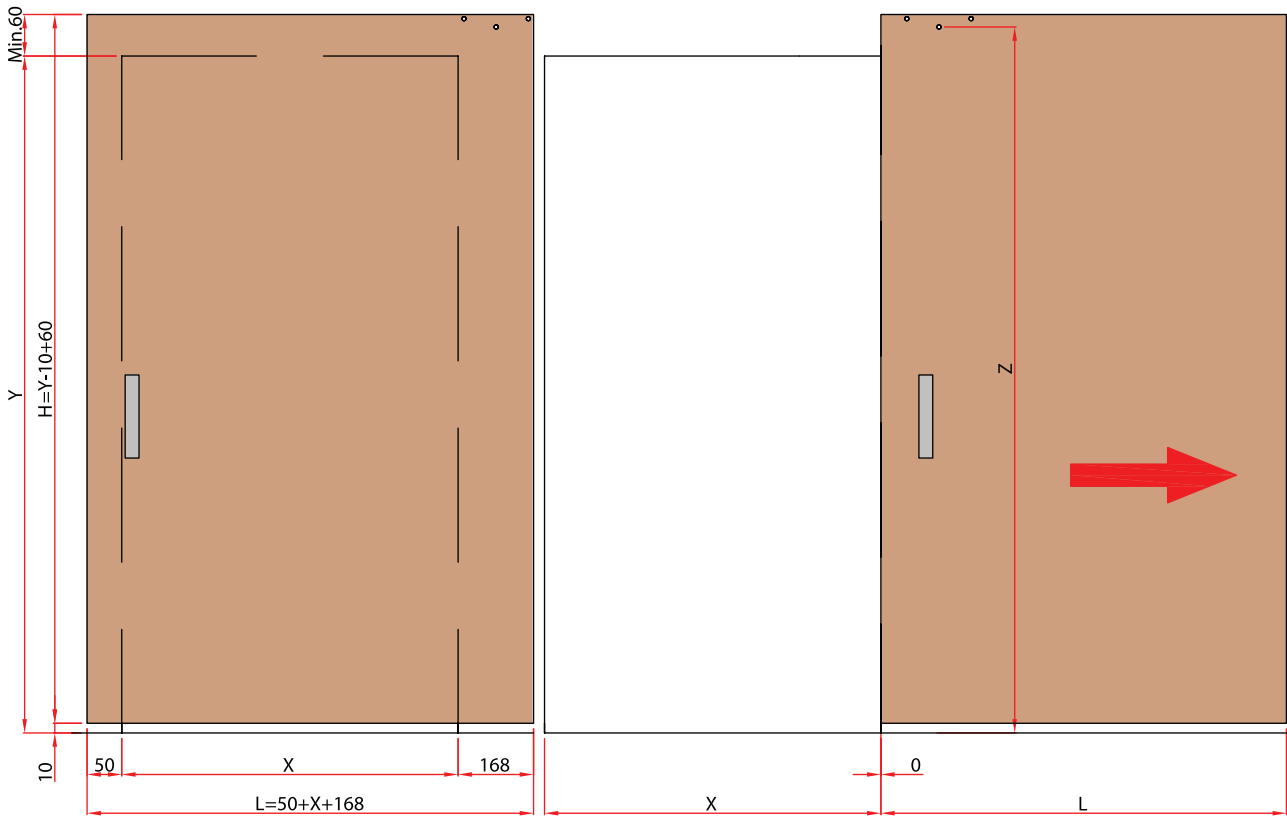

Установка двери

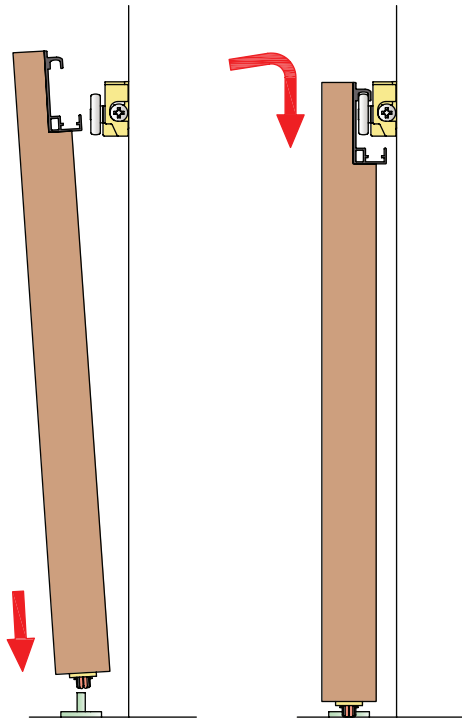

Регулировка по высоте

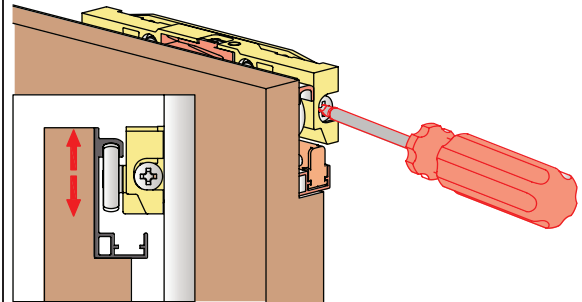

Активация блокировки зацепа

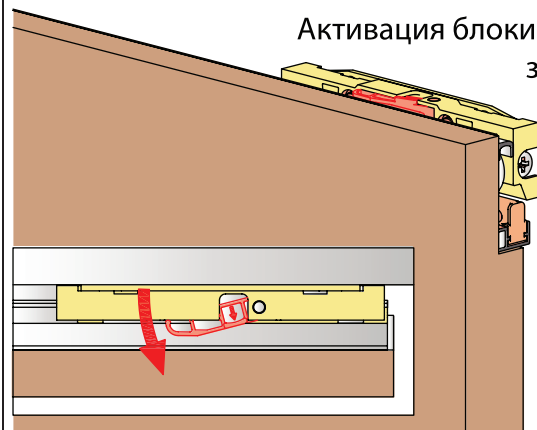

Активация доводчиков

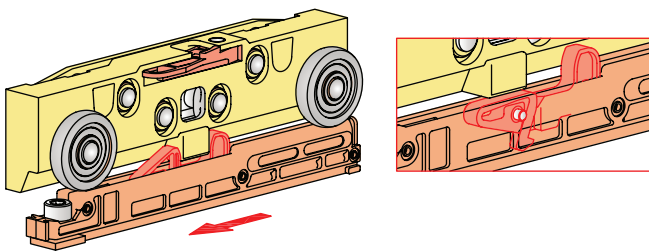

Активация доводчиков

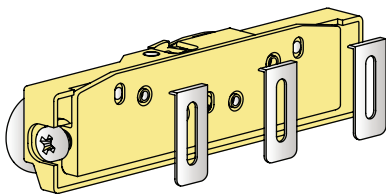
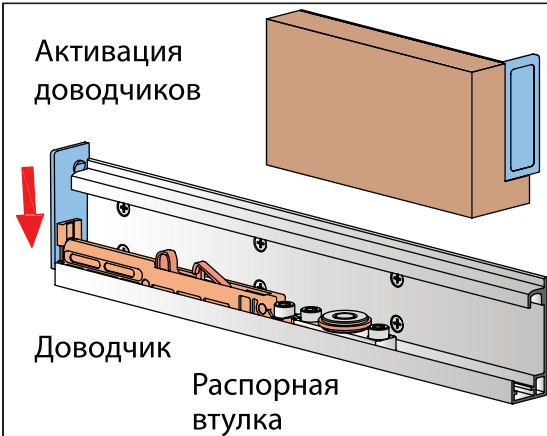

Выбор монтажных пластин различной толщины в зависимости от толщины стены

